

**Thin Film Array Chip Resistor
(TFAN Series)**

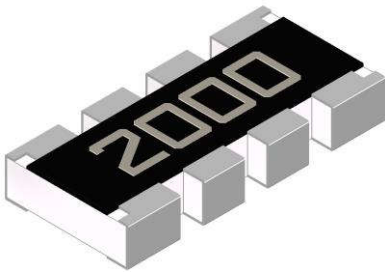

■ Features

- Advanced thin film technology
- Very tight tolerance down to $\pm 0.1\%$
- Extremely low TCR down to $\pm 10\text{PPM}/^\circ\text{C}$
- TCR tracking down to $15\text{ppm}(\pm 7.5\text{ppm})$ and tolerance matching down to $0.1\%(\pm 0.05\%)$
- RoHS compliant component, compatible with lead (Pb)-free

■ Applications

- Voltage divider
- Feedback circuits
- Signal conditioning

■ Construction

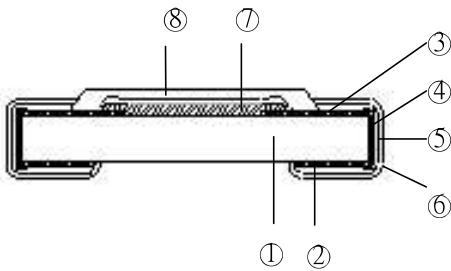

① Alumina Substrate	④ Edge Electrode	⑦ Resistor Layer
② Bottom Electrode	⑤ Barrier Layer	⑧ Overcoat
③ Top Electrode	⑥ External Electrode	

■ Equivalent Circuit Diagram

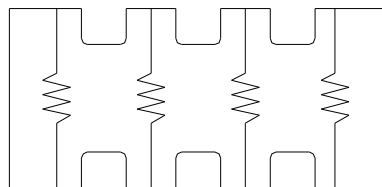

TFAN

■ Dimensions

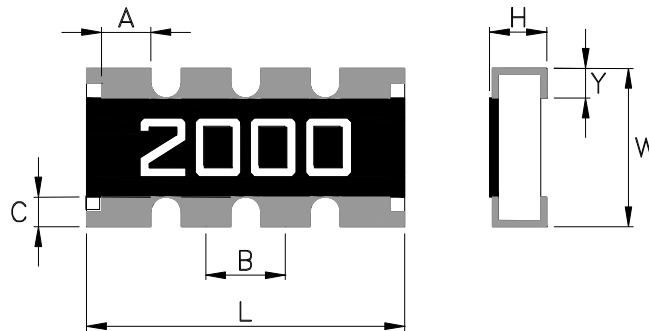

Type	Number of Resistors	L	W	H	A	B	C	Y
TFAN43	4	3.20±0.15	1.60±0.15	0.55±0.10	0.50±0.15	0.80±0.05	0.30±0.15	0.30±0.15

■ Part Numbering

TFAN	43	B0	T	C0	Y	1001	N
Product Type	Dimensions	Tolerance Grade	Packaging Code	TCR Grade	Power Rating	Resistance	Marking Code
	0603X4	Reference Tolerance Grade Table	T: Taping Reel B: Bulk	Reference TCR Grade Table	Y: 1/16W	1000: 100Ω 1001: 1KΩ 1211: 1.21KΩ 1004: 1MΩ	: Standard Marking for E96 N: No Marking

Accuracy Grade Table

Tolerance Grade				TCR Grade			
Code	Absolute Tolerance	Tolerance Matching	Resistance Value	Code	Absolute TCR	TCR Tracking	Resistance Value
B0	±0.1%	N/A	24.9~100K	B0	±10ppm	N/A	24.9~2K
B3	±0.1%	0.1%	24.9~100K	B3	±10ppm	15ppm	24.9~2K
C0	±0.25%	N/A	24.9~100K	N0	±15ppm	N/A	24.9~2K
C2	±0.25%	0.25%	24.9~100K	N3	±15ppm	15ppm	24.9~2K
C3	±0.25%	0.1%	24.9~100K	C0	±25ppm	N/A	24.9~100K
D0	±0.5%	N/A	24.9~100K	C2	±25ppm	25ppm	24.9~100K
D1	±0.5%	0.5%	24.9~100K	C3	±25ppm	15ppm	24.9~100K
D2	±0.5%	0.25%	24.9~100K	D0	±50ppm	N/A	24.9~100K
F0	±1%	N/A	24.9~100K	D1	±50ppm	50ppm	24.9~100K
F1	±1%	0.5%	24.9~100K	D2	±50ppm	25ppm	24.9~100K

Derating Curve

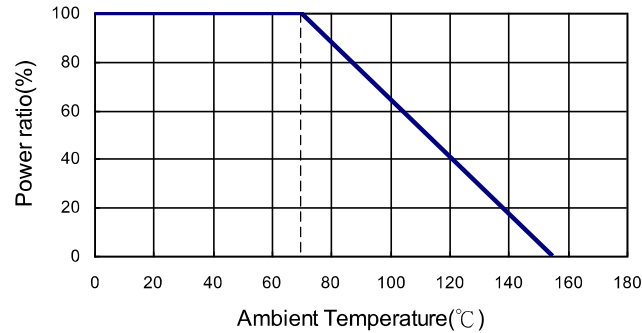

Electrical Specifications

Type	Item	Power Rating at 70°C	Operating Temp. Range	Max. Operating Voltage	Max. Overload Voltage	Resistance Range				TCR (PPM/°C)
						±0.1%	±0.25%	±0.5%	±1%	
TFAN 43		1/16W	-55 ~ +155°C	50V	100V	24.9Ω~100KΩ				±25 ±50

Special Specifications

Type	Item	Power Rating at 70°C	Operating Temp. Range	Max. Operating Voltage	Max. Overload Voltage	Resistance Range				TCR (PPM/°C)
						±0.1%	±0.25%	±0.5%	±1%	
TFAN 43		1/16W	-55 ~ +155°C	50V	100V	24.9Ω~2KΩ				±10 ±15

Operating Voltage= $\sqrt{P \cdot R}$ or Max. operating voltage listed above, whichever is lower.
 Overload Voltage= $2.5 \cdot \sqrt{P \cdot R}$ or Max. overload voltage listed above, whichever is lower.
 ■Viking is capable of manufacturing the optional spec based on customer's requirement.

■ Environmental Characteristics

Item	Requirement	Test Method
Temperature Coefficient of Resistance (T.C.R.)	As Spec.	MIL-STD-202 Method 304 +25/-55/+25/+125/+25°C
Short Time Overload	$\Delta R \pm 0.1\%$	JIS-C-5201-1 4.13 RCWV*2.5 or Max. overload voltage whichever is lower for 5 seconds
Insulation Resistance	>1000 M Ω	MIL-STD-202 Method 302 Apply 100V _{DC} for 1 minute
Endurance	1000Hr : $\Delta R \pm 0.15\%$ 8000Hr : $\Delta R \pm 0.3\%$	MIL-STD-202 Method 108A 70 \pm 2°C, RCWV with 1.5 hrs "ON" and 0.5 hrs "OFF"
Damp Heat with Load	$\Delta R \pm 0.25\%$	MIL-STD-202 Method 103B 40 \pm 2°C, 90~95% R.H., RCWV for 1000 hrs with 1.5 hrs "ON" and 0.5 hrs "OFF"
Damp Heat with Load(85°C/85% R.H)	$\Delta R \pm 0.5\%$	85 \pm 2°C, 80~90% R.H. 10% of RCWV for 1000 hrs with 1.5 hrs "ON" and 0.5 hrs "OFF"
Dry Heat	1000Hr : $\Delta R \pm 0.25\%$ 8000Hr : $\Delta R \pm 0.5\%$	At +125°C
Bending Strength	$\Delta R \pm 0.2\%$	JIS-C-5201-1 4.33 Bending amplitude 3 mm for 10 seconds
Solderability	95% min. coverage	MIL-STD-202 Method 208H 245 \pm 5°C for 3 seconds
Resistance to Soldering Heat	$\Delta R \pm 0.2\%$	MIL-STD-202 Method 210E 260 \pm 5°C for 10 seconds
Dielectric Withstand Voltage	100V	MIL-STD-202 Method 301 Max. overload voltage for 1 minute
Thermal Shock	$\Delta R \pm 0.25\%$	MIL-STD-202 Method 107G -55°C ~150°C, 100 cycles
Low Temperature Operation	$\Delta R \pm 0.25\%$	JIS-C-5201-1 4.36 1 hour, -65°C, followed by 45 minutes of RCWV

RCWV(Rated continuous working voltage)= $\sqrt{P \cdot R}$ or Max. Operating voltage whichever is lower

■ Storage Temperature: 15~28°C; Humidity < 80%RH

■ Reflow

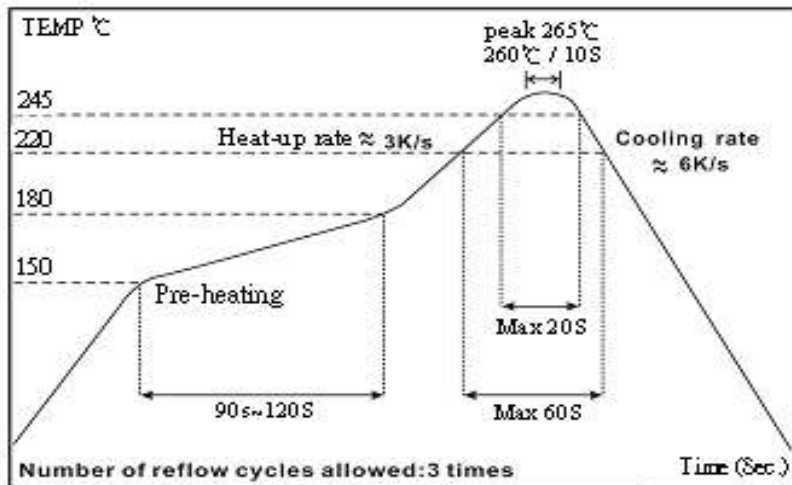

■Packaging

Reel Specifications & Packaging Quantity

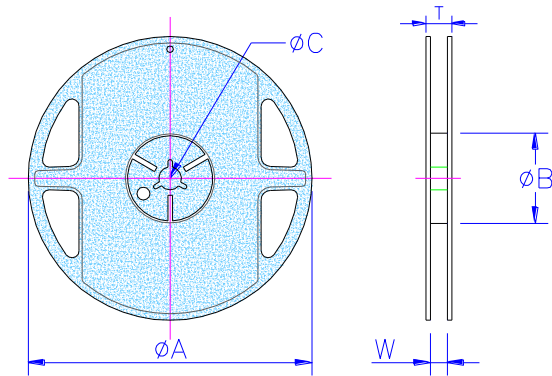

Unit: mm

Type	Packaging Quantity	Tape width	Reel Diameter	ϕA	ϕB	ϕC	W	T
TFAN 43	Paper 5K	8mm	7 inch	178.5±1.5	60 ^{+1/-0}	13.0±0.2	9.0±0.5	12.5±0.5

Paper Tape Specifications

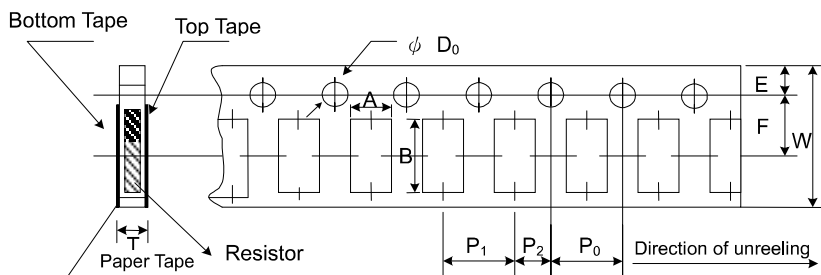

Unit: mm

Type	A	B	W	E	F	P_0	P_1	P_2	ϕD_0	T
TFAN-43	1.95±0.1	3.50±0.1	8.0±0.2	1.75±0.1	3.5±0.05	4.0±0.1	4.0±0.05	2.0±0.05	1.5 ^{+0.1/-0}	0.85±0.1

■Marking

TFAN 43: 4 digits marking

Example:

Resistance	100Ω	2.2KΩ	10KΩ	49.9KΩ	100KΩ
marking	1000	2201	1002	4992	1003

■Recommend Land Pattern

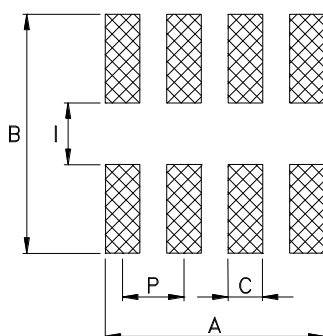

Unit: mm

Type	A	B	C	I	P
TFAN-43	3.10	2.85	0.45	0.80	0.80

REVISION HISTORY

REVISION	DATE	CHANGE NOTIFICATION	DESCRIPTION
Version B	Oct 31,2013	-	- Add $\pm 1\%$ Tolerance.
Version B1	May 13,2014	-	- Correct Land Pattern dimensions.
Version B2	Sep 04,2014	-	- Update Resistance value range.
Version B3	May 08,2015	-	- Correct the element of Top Electrode.
Version B4	May 02,2016	-	- Modify Storage Temperature. - Remove Material Description.
Version B5	Nov 10,2017	-	- Correct the reference standard in Environmental Characteristics.